

GREEN THE WORLD

**OPERATION MANUAL
PERSONNEL CARRIER & UTILITY VEHICLE**



Thanks for purchasing our electric **Personnel Carrier & utility vehicle** (here below named “vehicle”). This manual contains information for proper operation and maintenance of your vehicle. A thorough understanding of this manual will help you obtain maximum enjoyment from this vehicle. Please keep it properly for future reference.

Important Information:

There are two types personnel carriers, we name them 02 & 03 style vehicle whose design are significant different, Please first recognize which style vehicle you have, and then follow the respective instructions in this manual.

Particularly important information is distinguished by the following notations:

WARNING!

Fail to follow Warning instructions could result in severe injury to the vehicle occupants, bystanders or persons inspecting or repairing the vehicle.

CAUTION!

Fail to follow Caution instructions could cause damage to the vehicle.

Special Notices:

Because the seat & backrest wrapping film may stick to the seat vinyl and cause seat vinyl fading or being stained, please remove the seat & backrest wrapping film when you start to use the vehicle!

If you have to stock the vehicle for a long time, please also remove the seat & backrest wrapping film.

Pictures for reference!!

Standard Personnel Carrier (4-seater personnel carrier includes 02 & 03 style)



4-seater Personnel Carrier(03 style)



4-seater Personnel Carrier (02 style)



6-seater Personnel Carrier

Utility cargo vehicle based on Personnel Carrier



2-passenger with short cargo bed



2-passenger with short cargo bed

Utility dining vehicle based on Personnel Carrier



2-passenger with short dining box



2-passenger with long dining box

Closed electric vehicle



4-passenger electric vehicle



6-passenger electric vehicle

INDEX

1. Overview	01
2. Safe Operation Instructions	04
3. Technical Data	05
4. Controls	08
5. Operation	15
6. Maintenance	16
7. Main Trouble and troubleshooting	26
8. Lubrication	28
9. Running-in of new vehicle	29
10. Periodic Maintenance Charts	29
11. Storage	31
12. Wiring Diagram	31

1. OVERVIEW

Our vehicle is environment-friendly, and it can be used as people mover or utility car in golf course, vacation villages, villa areas, resort hotels, private residential areas, tourist scenic spots, or any other places where this type of vehicle is allowed.

WARNING!

Please always be sure of whether there is any restriction in the area where you intend to use the vehicle to avoid any unpleasant experience.

IMPORTANT LABELS

SAFETY LABEL

Read carefully and understand the contents on the safety label attached on the vehicle.

(Below pictures shows the position of the safety labels on 03 & 02 vehicles)

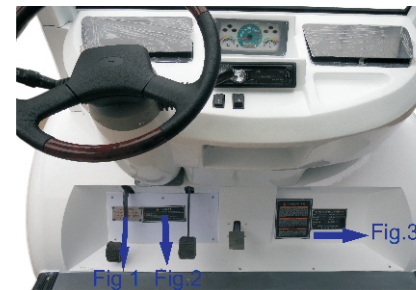

Safety labels on 03 style vehicle

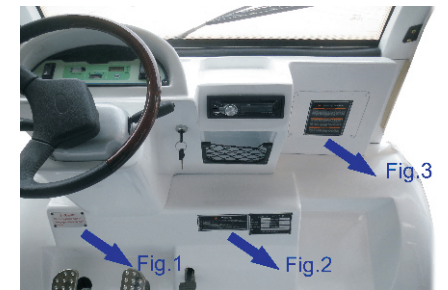

Safety label on 02 style vehicle

Label content of the safety labels

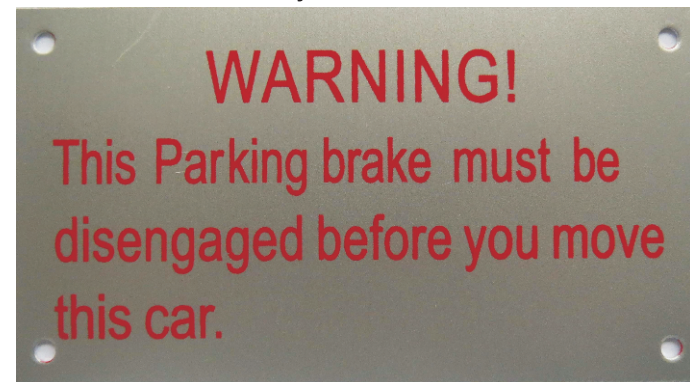

Fig. 1

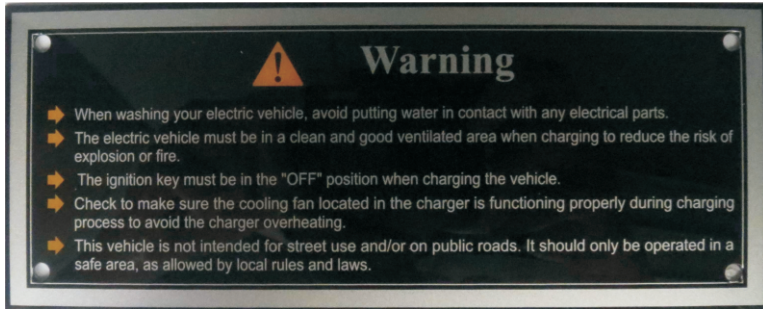

Fig.2

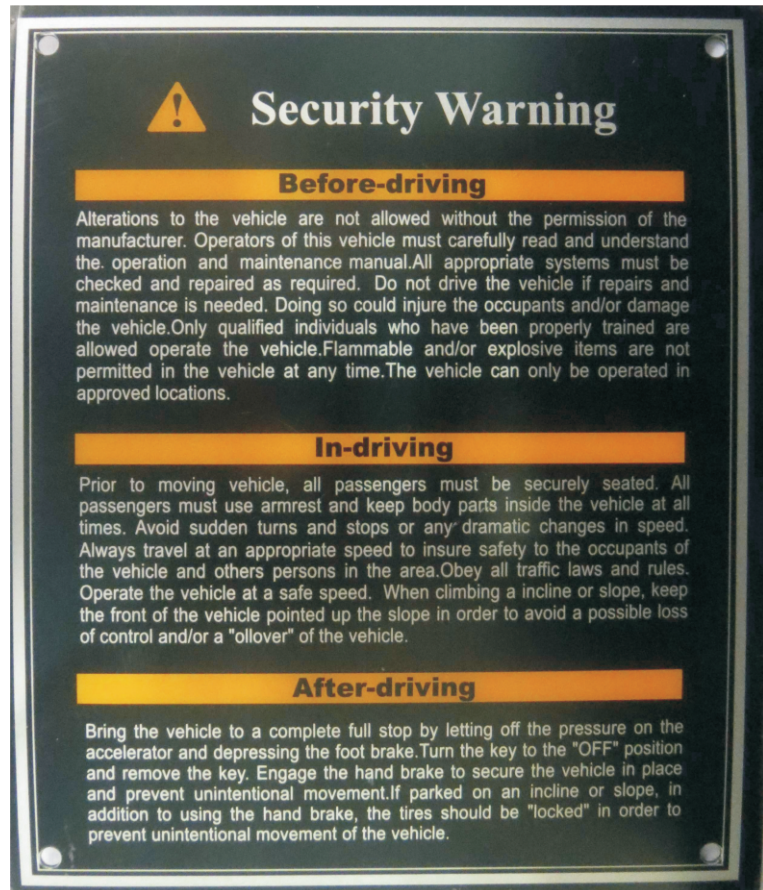

Fig.3

Vehicle Information (Name Plate)

The name plate is at the low part of the dashboard as below: Fig. 1 shows the position of the name plate for 03 style vehicle; Fig .2 shows the position of the name plate for 02 style vehicle.



Fig.1

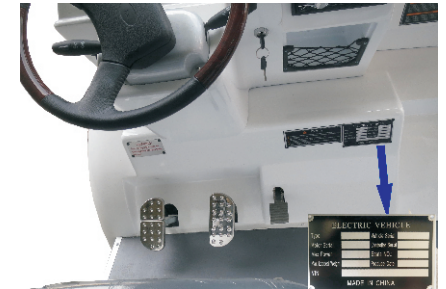

Fig.2

Chassis number of the vehicle:

The position where the chassis number is located showed as below picture.



2. SAFE OPERATION INSTRUCTIONS

Our vehicle is designed for simple operation; however, please make sure you observe following safe operation instructions:

BEFORE OPERATING:

- ALWAYS read this first before you start driving the vehicle.
- ONLY authorized people drive this vehicle, from the driver's side ONLY
- Drive the vehicle ONLY in areas where the vehicle is allowed by law or local regulations and under safe condition.
- DO NOT allow more people than the allowed on the vehicle.
- DO NOT overload in any case, otherwise the motor may be damaged, the vehicle may also lose control and/or the driver and passengers will be in danger.
- DO NOT operate the vehicle after alcohol or drugs, otherwise, their affect on vision and judgment will put the driver and passenger in danger.
- DO NOT climb any slope beyond its gradeability.
- DO NOT overtake other vehicles at crossroads, in blind areas or in any dangerous areas.

WHILE OPERATING THE VEHICLE

- Keep your entire body inside the vehicle, keep seated and hold on while the vehicle is moving.
- Do not start the vehicle until all occupants are securely seated.
- Keep your hands on the steering wheel and your eyes on the path you are going.
- Always back up slowly, and watch the back carefully.
- Avoid starting or stopping suddenly.
- Avoid turning the steering wheel too sharply at higher speed.
- Always drive slowly up or down on the incline.
- Do not make any modification or addition which may affect the capacity or safety
- Children are not allowed to play on the vehicle. Children should be seated between adults and protected by them when the vehicle is moving.

3. TECHNICAL DATA

The data below have been confirmed by an independent authority lab.

Standard Personnel Carrier

ITEMS	4-Seater Personnel Carrier (03 & 02 style)	6-Seater Personnel Carrier
Voltage (V)	48V	48V
Battery Setup	8pcs x 6V	8pcs x 6V
Dimensions (mm) (L x W x H)	3060x1400x1900 (03 style) 3050x1400x1800 (02style)	3750X1400X1810
Range (km/h) based on flat road at a speed of 20km/h	> 80 > 105(AC system)	> 75 > 90(AC system)
Maximum Speed (km/h) for Gear Ratio of 12.49:1	32 for 4KW / 5KW DC motor 40 for 4KW / 5KW AC motor	32 for 4KW / 5KW DC motor 40 for 4KW / 5KW AC motor
Maximum Speed (km/h) for Gear Ratio of 10.25:1	40	40
Minimum Turning Diameter (m)	8	8
Maximum Loading Capacity (Kg)	370	530
Maximum Gradeability	20%	20%
Noise (dB)	≤70	≤70
Maximum Brake Distance (V=20km/h)	< 4	< 4

Utility cargo vehicle based on Personnel Carrier

ITEMS	2-Passenger with short cargo box	2-Passenger with long cargo box
Voltage (V)	48V	48V
Battery Setup	8pcs x 6V	8pcs x 6V
Dimensions (mm) (L x W x H)	3050x1400x1800	3750X1400X1810
Dimensions of cargo box (mm) (L x W x H)	1200x1100x250	1600X990X250
Range (km) based on flat road at a speed of 20km/h	> 70 >90(AC system)	> 70 >90(AC system)
Maximum Speed (km/h) for Gear Ratio of 12.49:1	32 for 4KW / 5KW DC motor 40 for 4KW / 5KW AC motor	32 for 4KW / 5KW DC motor 40 for 4KW / 5KW AC motor
Minimum Turning Diameter (m)	8	8
Maximum Loading Capacity (Kg)	480	530
Maximum Gradeability	20%	20%
Noise (dB)	70	70
Maximum Brake Distance (V=20km/h)	< 4	< 4

Utility dining vehicle based on Personnel Carrier

ITEMS	2-Passenger with short dining box	2-Passenger with long dining box
Voltage (V)	48V	48V
Battery Setup	8pcs x 6V	8pcs x 6V
Dimensions (mm) (L x W x H)	3050x1400x1800	3750X1400X1810
Dimensions of cargo box (mm) (L x W x H)	1000X1080X990	1500X1080X990
Range (km) based on flat road at a speed of 20km/h	> 70 >90(AC system)	> 70 >90(AC system)
Maximum Speed (km/h) for Gear Ratio of 12.49:1	32 for 4KW / 5KW DC motor 40 for 4KW / 5KW AC motor	32 for 4KW / 5KW DC motor 40 for 4KW / 5KW AC motor
Minimum Turning Diameter (m)	8	8
Maximum Loading Capacity (Kg)	370	530
Maximum Gradeability	20%	20%
Noise (dB)	70	70
Maximum Brake Distance (V=20km/h)	< 4	< 4

Closed electric vehicle

ITEMS	4-passenger electric vehicle	6-passenger electric vehicle
Voltage (V)	48V	48V
Battery Setup	8Pcs x 6V	8Pcs x 6V
Dimensions (mm) (L x W x H)	3060x1400x1900	3750X1400X1810
Range (km) based on flat road at a speed of 20km/h	>50 >65(AC system)	>60 >70(AC system)
Maximum Speed (km/h) for Gear Ratio of 12.49:1	30 for 4KW motor 32 for 4KW motor / 5.3KW motor / 5KW AC motor	30 for 4KW / 5.3KW motor 32 for 5KW AC motor
Minimum Turning Diameter (m)	4	4
Maximum Loading Capacity (Kg)	320KGS	530KGS
Maximum Gradeability	20%	20%
MAXIMUM BRAKE DISTANCE (V=20KM/H)	≤4	≤4

4. CONTROLS

1) **Schematic Figure of controls** (There are two types of dashboard on the vehicles, we name them 02&03 Style Dashboard whose design are significant different, Please first recognize which style of dashboard your vehicle has, then follow the below instruction)

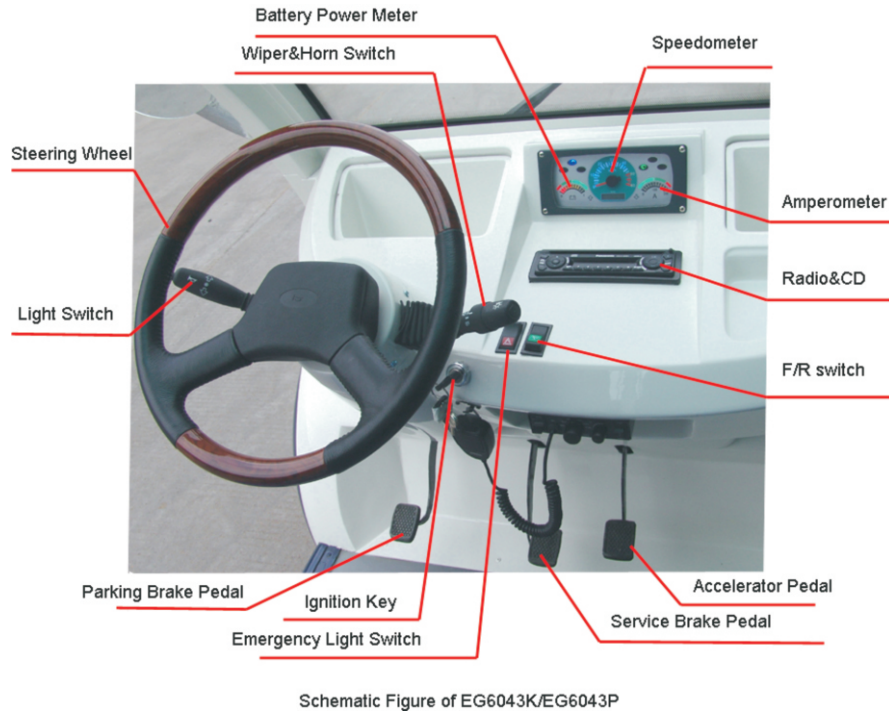

Fig.1 (for 03 style vehicle)

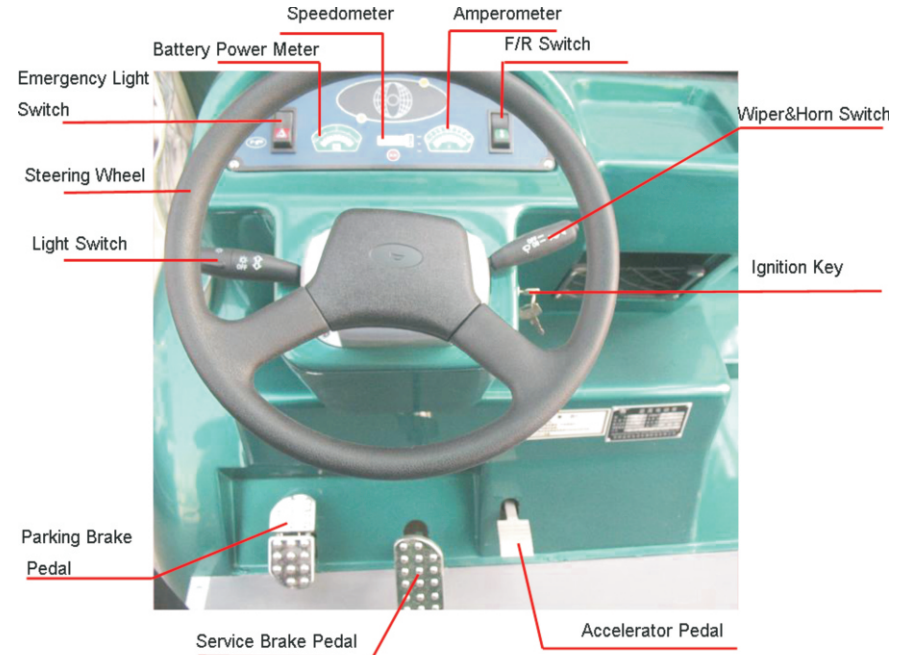
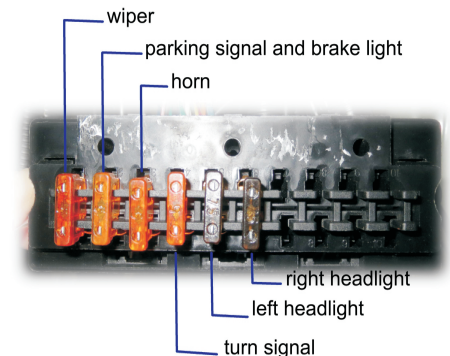
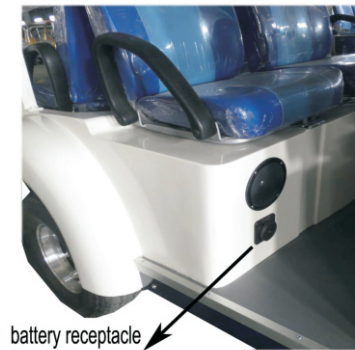

Fig. 2 (for 02 style vehicle)



2) Functions of Controls

Power key

The power key is used to switch on the electrical system of the vehicle.

To engage the motor and start the vehicle, Insert the key and turn it clockwise to the ON position, at the same time, the 12V accessory system (including the headlight, turn signal, taillight, brake light and horns) will be engaged too.

To switch the power off, turn the key counterclockwise to OFF position.

CAUTION!

When the Key is on 'ON' position, the key cannot be pulled out.

Don't try to pull out the Key when it's on 'ON' position!



Forward/reverse switch

This is a three-position switch, depressing the upper part gets the vehicle moving forwards while depressing the lower part gets the vehicle moving backwards, and the middle is neutral.

WARNING! This switch must be fully depressed into the proper position, or the electric system and motor will be damaged.

NOTE: The buzzer will beep when the lower part of this switch is depressed, to warning people around your vehicle.



Accelerator pedal

The accelerator pedal is used to control the speed when driving. Step it down slowly to increase the speed. The vehicle will speed up with the gradual stepping down the accelerator pedal, eventually reaching the full speed when the pedal is stepped down to the bottom. The vehicle slows down with the lifting of the pedal. When the pedal is fully lifted, electric brake will start to work, and the vehicle will stop.



Service Brake pedal

The service brake pedal is used in braking (Fig 1 is for O2 style vehicle and Fig. 2 is for O3 style vehicle)



Parking Brake Pedal

The parking brake pedal is used in braking for parking. The parking brake should be engaged into parking position whenever the vehicle is left unattended. ((Fig 1 is for O3 style vehicle and Fig. 2 is for O2 style vehicle)



Fig.1

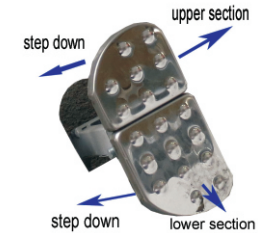

Fig.2

How to engage and disengage the parking brake?

To engage the parking brake

For O3 style vehicle, step down the parking brake pedal by foot until it's hooked

For O2 style vehicle, step down upper section of the parking pedal by foot until it's hooked.

To disengage the parking brake,

For O3 style vehicle, step down the parking brake pedal to the end until the parking brake pedal is unhooked.

For O2 style vehicle, step down lower section of the parking to the end until parking brake pedal is unhooked.

WARNING!

Please always disengage the parking brake pedal before you drive the vehicle otherwise will damage the brake system and motor badly.

WARNING!

It is prohibited to step down both parking / brake parking brake pedal and accelerator pedal all together; otherwise will damage the motor badly.

Steering wheel

The steering wheel is used to control the driving direction. Please avoid any sudden and wild turn.

TOW/RUN SWITCH (available for Curtis 1268 controller)

Before operating the vehicle, make sure the TOW/RUN switch is on 'RUN' position.

Make sure the TOW/RUN switch is on the 'TOW' position if towing the vehicle.

The TOW/RUN switch is located under the dashboard as showed below picture.



NOTE: When the TOW/RUN switch is on the 'RUN' position, the vehicle will beep when push the vehicle to remind you.

WARNING!

Whenever the TOW/RUN switch is moved from the RUN position to the TOW position, please move it back to the RUN position, there is a delay of approximately 30 seconds before the vehicle will run.

COMBINATION SWITCH:

Combination switch includes left lever and right lever: the left lever of the switch is used to switch on/off the lighting system including headlight, front turn signal, rear turn signal, taillight; the right lever is to control the wiper and horn. (**Fig 1 for 03 style vehicle, Fig 2 for 02 style vehicle**)

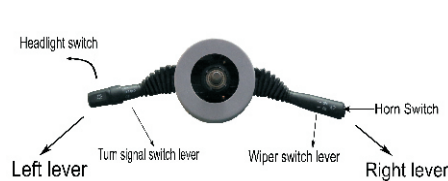

Fig.1

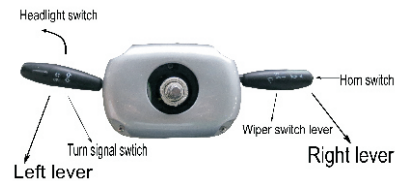

Fig.2

Left lever:

It's used to control the lights including headlight, taillight and turning light.

- 1) Turn the top button to power on the headlight and taillight; and turn back to power off the headlight and taillight.
- 2) Push the lever to the front to engage the right turning light when planning to turn and drive the vehicle to the right.
- 3) Push the lever to the rear to engage the left turning light when planning to turn and drive the vehicle to the left.

Right lever

It's used to control the wiper and horn

Wiper switch: This switch is used to control windshield wiper..

NOTE: The operation of the wiper switch for 03 style vehicle and 02 style vehicle is different.



Fig.1



Fig.2

The operation of the wiper switch for 03 style vehicle please refer to Fig.1

- 1.)push the wiper level to the bottom to switch on the wiper
- 2.)push the wiper lever to the middle position to switch off the wiper
- 3.)push the wiper level to the top position to reset the wiper

The operation of the wiper switch for 02 style vehicle please refer to Fig.2

- 4.)push the wiper level to the bottom to switch off the wiper
- 5.)push the wiper lever to the middle position to switch on the wiper
- 6.)push the wiper level to the top position to reset the wiper

Horn Switch: Press the top button of the lever to activate the horn.



Emergency Light Switch—the emergency light switch is located nearby the digital dashboard, press the lower part of the button, the front and rear left and right turn lights will turn on and flash to warning people around the vehicles. Press the upper part of the button to shut down.

DIGITAL DASHBOARD:

(**Fig 1 for 03 style vehicle, Fig 2 for 02 style DC vehicle, Fig 3 for 02 style AC vehicle**)



Fig.1



Fig.2

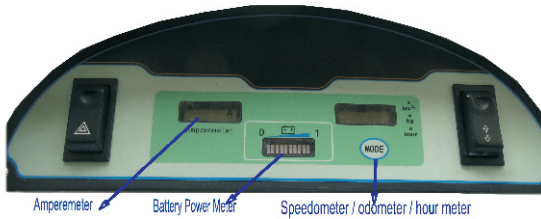

Fig.3

Speedometer / Odometer---Indicate the running speed of the vehicle and accumulated distance the vehicle has run. For 02 style vehicle, press the button “MODE”, the meter will show speed, accumulated distance and hours the vehicle has run, for 03 style vehicle, the speed, accumulated distance will show on digital dashboard directly.

Amperemeter —— Indicate the current of the working vehicle.

Battery Power Meter

There are 10 divisions on the meter (from 0 to 1). The meter will decline from the top to the bottom as the battery discharges. When the battery is too low, the red indicator light will flash, reminding you to recharge the battery.

NOTE: please refer to your Battery Chargers Owners Manual for how to recharge the batteries.

5. OPERATION

STARTING:

a)Disengage the parking brake pedal.

CAUTION!

Failed to disengage the parking brake when driving the vehicle will cause motor burning!

b)With the Forward/Reverse switch on the Neutral position, turn the power key to ON position.

CAUTION!

The car will not run if press down the F/R switch to Forward or Reverse position before turns the power key when it's equipped with AC system.

c)Press the Forward/Reverse switch and lock it in the desired position.

WARNING!

Do not shift the from Forward ↑ to Reverse ↓ or from Reverse ↓ to Forward ↑ when the car is moving.

d)Step down on the acceleration pedal slowly, the vehicle will start to move.

WARNING!

Do not step down the accelerator pedal when turning on the power key, otherwise, the vehicle may suddenly start moving.

CAUTION:

If the accelerator pedal is stepped down before the power key is on, the vehicle will not run. In this case, you should release the accelerator pedal first, and then turn the power key ON, then step down the accelerator pedal again, the vehicle will start moving.

STOPPING:

To stop the vehicle, gradually press down the brake pedal. When the vehicle has come to a stop, apply the parking brake pedal and turn the power key to OFF and press the F/R switch on Neutral position.

CAUTION:

Do not hold the vehicle on an incline with the accelerator, please use the brake.

6. MAINTENANCE

Users should perform regular maintenance to ensure the vehicle is in good performance.

MAINTENANCE OF BATTERY

NOTE: Our standard vehicles are equipped with deep-cycle flooded lead-acid batteries. If your vehicle is equipped with other types of batteries, please follow the maintenance instruction by the battery manufacturer. Below maintenance instruction is especially for deep-cycle flooded lead-acid battery.

WARNING! Battery electrolyte is poisonous and dangerous, and may cause severe burns, injury, and etc. Always wear protective clothing, gloves, and goggles when handling batteries, electrolyte, and charging your battery.

KEEP OUT THE REACH OF CHILDREN.

1) Cleaning

a. The exterior of the battery, the connection wires and bolts should always be kept clean and dry. When cleaning, please make sure all vent caps are tightly in place. Clean the battery top with a cloth or brush and solution of baking soda and water. When cleaning, do not allow any cleaning solution, or other foreign matter to get inside of the battery. This should be done

every week.

b. Clean battery terminals and the inside of cable clamps using a post and clamp cleaner. Clean terminals will have a bright metallic shine. This should be done when it is necessary.

c. Reconnect the clamps to the terminals and thinly coat them with petroleum jelly (Vaseline) to prevent corrosion.

WARNING! Before you disconnect any battery cable from any terminal on the battery, please always remove the power by disconnecting the main battery cable from the controller.

2) Checking the terminals and nuts

The connection of the battery should always be kept in good condition. Please check **every week** on whether any battery cable terminal or nut has become loose in order to prevent any sparkle or damage to terminals. Please check **every week** whether any battery cable is damaged or not, the damaged battery cable should be replaced immediately.

3) No foreign matter

Do not place any objects on the battery and do not connect the positive pole to the negative pole. This may cause a short circuit, dangerous spark or may cause damage to the battery or injury to the user

4) Recharging

a. As long as you use the vehicle, regardless of how long you have used it, the battery shall be recharged fully on the same day. Any delay on the re-charging will cause negative effect on the battery.

Notes: the lead-acid battery does not develop a memory, so need not be fully discharged before recharging.

b. If the vehicle is going to be kept unused for a long time, the battery shall be fully recharged first. After that, the battery should be fully recharged every 2 weeks.

c. When driving, the driver shall be always aware of the drop level of the battery power from the battery power meter, any drop means the battery power is diminishing.

Besides, the driver should estimate the distance needed to be taken, and recharge the battery at a proper time in case that the vehicle cannot get back to the recharging station in time for recharging.

WARNING! Please make sure the battery is recharged before the battery power meter shows 20% is left only. Over-discharged battery will have a very short service life and will make the recharging very difficult.

WARNING! During recharging, the vehicle shall be parked in a well-ventilated area with filling caps tightly secured. Keep far away from any flame and sparks to avoid any explosion or fire that could cause physical injury or damage to the property.

5) WATERING

Flooded batteries need water. What's more, watering must be done at the right time and in the right amount or else the battery's performance and longevity suffers.

Water should always be added after fully charging. Prior to charging, there should be enough water to cover the plates. If the battery has been discharged (partially or fully), the water level should also be above the plates. Keeping the water at the correct level after a full charge, then you will not have to worry about the water level at a different state of charge.

Depending on the local climate, charging methods, and application, etc., Trojan recommends that batteries be checked once a month until you get a feeling for how thirsty your batteries are.

Important things to remember:

1. Do not let the plates get exposed in the air. This will damage (corrode) the plates.
2. Do not fill the water to the cap. This most likely will cause the battery to overflow acid, consequently losing capacity and causing a corrosive mess.
3. Do not use water with a high mineral content. Use distilled or demineralized water only.

CAUTION:

The electrolyte is a solution of acid and water so skin contact should be avoided.

Step by step watering procedure:

1. Open the vent caps and look inside the filling wells.
2. Check electrolyte level; the minimum level is at the top of the plates.
3. If necessary add just enough water to cover the plates once.
4. Put batteries on a complete charge before adding water (refer to the Charging section).
5. Once charging is completed, open the vent caps and look inside the fill wells.
6. Add water until the electrolyte level is 1/8" below the bottom of the fill well.
7. A piece of rubber can be used safely as a dipstick to help determine this level.
8. Clean, replace, and tighten all vent caps.

WARNING! Never add acid into the battery.

6) TESTING

Visual inspection alone is not sufficient to determine the overall health of the battery. Both open-circuit voltage and specific gravity readings can give a good indication of the battery's charge level, life span, and health. Routine voltage and gravity checks will not only show the state of charge but also help spot signs of improper care, such as undercharging and over-watering, and possibly even locate a bad or weak battery. The following steps outline how to properly perform routine voltage and specific gravity testing on batteries.

I. Specific Gravity Test

(Flooded batteries only)

1. Do not add water.
2. Fill and drain the hydrometer 2 to 4 times before pulling out a sample.
3. There should be enough sample electrolyte in the hydrometer to completely support the float.
4. Take a reading, record, and return the electrolyte back to the cell.
5. To check another cell, repeat the 3 steps above.
6. Check all cells in the battery.
7. Replace the vent caps and wipe off any electrolyte that might have been spilled.
8. Correct the readings to 80° F: Add .004 to readings for every 10° above 80° F, Subtract .004 for every 10° below 80° F.
9. Compare the readings.
10. Check the state of charge using Table 1.

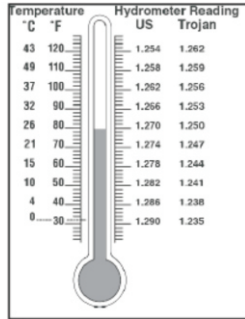
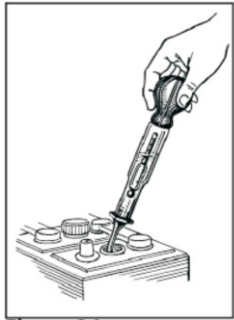

The readings should be at or above the factory specification of 1.277 +/- .007. If any specific gravity readings register low, then follow the steps below.

1. Check and record voltage level(s).
2. Put battery(s) on a complete charge.
3. Take specific gravity readings again.

If any specific gravity readings still register low then follow the steps below.

1. Check voltage level(s).
2. Perform equalization charge. Refer to the Equalizing section for the proper procedure.
3. Take specific gravity readings again.

If any specific gravity reading still registers lower than the factory specification of 1.277 +/- .007 then one or more of the following conditions may exist:

1. The battery is old and approaching the end of its life.
2. The battery was left in a state of discharge too long.
3. Electrolyte was lost due to spillage or overflow.
4. A weak or bad cell is developing.
5. Battery was watered excessively previous to testing.

Batteries in conditions 1 - 4 should be taken to a specialist for further evaluation or retired from service.

II. Open-Circuit Voltage Test

For accurate voltage readings, batteries must remain idle (no charging, no discharging) for at least 6 hrs, preferably 24 hrs.

1. Disconnect all loads from the batteries.
2. Measure the voltage by a DC voltmeter.
3. Check the state of charge with Table 1.
4. Charge the battery if it registers 0% to 70% charged.

If the battery value is lower than that in Table 1, the following conditions may exist:

1. The battery was left in a state of discharge too long.
2. The battery has a bad cell.

Batteries in these conditions should be taken to a specialist for further evaluation or retired from service.

TABLE 1. State of charge as related to specific gravity and open circuit voltage

Percentage of Charge	Specific Gravity Corrected to 80°F	Open-Circuit Voltage					
		6V	8V	12V	24V	36V	48V
100	1.277	6.37	8.49	12.73	25.46	38.20	50.93
90	1.258	6.31	8.41	12.62	25.24	37.85	50.47
80	1.238	6.25	8.33	12.50	25.00	37.49	49.99
70	1.217	6.19	8.25	12.37	24.74	37.12	49.49
60	1.195	6.12	8.16	12.24	24.48	36.72	48.96
50	1.172	6.05	8.07	12.10	24.20	36.31	48.41
40	1.148	5.98	7.97	11.96	23.92	35.87	47.83
30	1.124	5.91	7.88	11.81	23.63	35.44	47.26
20	1.098	5.83	7.77	11.66	23.32	34.97	46.63
10	1.073	5.75	7.67	11.51	23.02	34.52	46.03

7) Battery installation

WARNING!

When working with the battery, DO NOT put wrenches or any other metal objects across the battery terminals, otherwise, an arc can occur, and it may cause explosion of the battery and physical injury.

Battery is installed or replaced only by the qualified electrician.

8) BATTERY CHARGING

NOTE: We provide two types of chargers for our vehicle, one is non-onboard charger, and another is onboard charger. The standard charger is non-onboard charger. Check your vehicle which kind of charger it is? The onboard charger is either installed in the rear bag well, or under the seat, or under the front body.

When it's onboard charger, a separate charging cord will be provided with the vehicle for connecting the charger and AC electricity.

WARNING!

Before you use the charger, please read the operation manual provided with the charger.

WARNING!

Explosive hydrogen gas is produced while battery is charged. Only charge the battery in well-ventilated areas.

WARNING!

Before using the charger, please check if the battery charger you are getting to use is correctly rated as per your local AC electricity network.

WARNING!

When using new battery, make sure new battery is in same specifications as original one and is appropriate in application.

The following is the charging steps:

- 1) Turn the power key to OFF.
- 2) Connect the DC output plug to the vehicle receptacle; and then connect it to your local AC power outlet.

WARNING!

Do not disconnect the DC output cord from the battery receptacle when the charger is ON, otherwise an arc could occur which may cause an explosion.

- 3) The charger will turn off automatically when the battery is charged fully.

WARNING!

For non-onboard charger, the battery receptacle is combined with a security switch which can cut off the power of the vehicle when the battery is being charged, so the vehicle cannot be started as long as the DC plug is plugged into the battery receptacle. For onboard charger, the vehicle can be driven when the charger is connected! Do not try to drive the vehicle when the charger is connected to avoid any possible damage to the charger or vehicle.

- 4) After the charger turns off, disconnect the plug on the AC charging cable from the AC power outlet first, and then disconnect the DC output plug from the vehicle receptacle.

- 5) It is prohibited to open the housing of the charger.
- 6) Only qualified electrician is allowed to open the housing of the charger.
- 7) The charger should be stored in safe and dry room with good ventilation.
- 8) The charger should be packed properly if not used for long time.

- 9) Read carefully the operation manual for the charger for detailed operation instructions.

Equalizing charge

Equalizing is an overcharge performed on flooded lead acid batteries after they have been fully charged. It reverses the buildup of negative chemical effects like stratification, a condition where acid concentration is greater at the bottom of the battery than at the top. Equalizing also helps to remove sulfate crystals that might have built up on the plates. If left unchecked, which is called sulfation, will reduce the overall capacity of the battery.

When the battery is fully charged, if keeping it connected with the charger, every 8 hours, the charger will charge 8 minutes to maintain the battery, after 20 hours, equalizing charge will start and last 2 hours. Equalizing charge can also be started manually by pressing down the 'STOP' button for 5 seconds when charging. Equalizing charge will start in 1 hour when the battery is fully charged.

Equalizing is recommended when low or wide ranging specific gravity (+/- .015) is detected after fully charging a battery.

Maintenance of the Traction DC Motor

WARNING! No explosive gas vapor is in the air, otherwise, it may cause severe injury and damage to your body and property if the explosive gas vapor contacts the sparks generated from the motor.

- 1) For DC motor, the carbon brush should be checked every 3 months to see if it is worn or not as it is an easily worn part. If it is not replaced in time before it wears out, it will damage the motor badly.
- 2) Do not keep the motor running idly for long periods of time. Any idle running of the motor should be avoided.
- 3) Removal of mud, sand and other clinging objects shall be done frequently to facilitate the heat-radiation.
- 4) Periodically use low pressure air to remove the dust from the carbon brush and the commutator. Periodically check the connection of the carbon brush and the commutator.

Main malfunction and possible reason of DC motor

Item	Symptoms	Possible Causes
1	All copper plates turn black.	The pressure of brush is incorrect.
2	The commutating copper turns black in a certain order and in groups.	Short circuit happens between the commutating copper or among the armature coil; poor welding or disconnection happens between the commutating copper and the armature coil.
3	The commutating copper turns black disorderly.	The central line of the commutator deviates or its surface is not round and not smooth.
4	The brush wears out, changes colors and breaks.	The motor vibrates; the clearance between the brush and its holder is too big; the clearance between the brush and commutator is too big; the mica between different commutator extrudes; the brush is made by wrong materials; the brush is wrong in type.
5	Big sparkles	The motor is over-loaded; the commutator are not clean, not round or not smooth; mica or some commutator extrude; the brush is not ground properly; the brush is big in pressure; the brush is wrong in type; the brush is jammed in the brush holder; the brush holder become loose or vibrating; the polarity and sequence of magnetic poles become wrong.
6	The brush and its wires get hot.	Big sparkles from the brush; poor contact between brush and soft wires; small section area of soft wires.
7	The brush is noisy	The surface of the commutator is not smooth.

Caution: Only Qualified Electrician Can Change And Adjust The Carbon Brush And Commutator.

Maintenance of the Traction AC Motor

If your vehicle is equipped with AC motor, then the motor is maintenance free!

Maintenance of the Controller:

CAUTION

Only qualified electrician is allowed to do the maintenance for the controller.

WARNING!

There is no spare part available inside the controller. No attempt should be made to open, repair, or otherwise modify the controller. Doing so may damage the controller and will void the warranty.

CLEANING

It is recommended that the controller be kept clean and dry and that its fault history file be checked and cleared periodically.

Periodically cleaning the controller exterior will help protect it against corrosion and possible electrical control problems created by the dirt, grime, and chemicals that are part of the operating environment and that normally exist in battery powered systems.

Please use the following cleaning procedure for routine maintenance:

- 1) Turn the power key to OFF position.
- 2) Remove power by disconnecting the battery.
- 3) Discharge the capacitors in the controller by connecting a load (such as a contactor coil or a horn) across the controller's B+ and B- terminals.
- 4) Remove any dirt or corrosion from the connector areas. The controller should be wiped clean with moist rag. Dry it before reconnecting the battery. The controller should not be subjected to pressured water flow from either a standard hose or a power washer.
- 5) Make sure the connections are tight, but do not over tighten them.

Faulty History File

The handheld programmer (to be ordered separately) can be used to access the controller's fault history file. The programmer will read out all the faults the controller has experienced since the last time the history file was cleared. Faults such as contactor faults may be the result of loose wires; contractor wiring should be carefully checked. Faults such as over temperature may be caused by operator habits or by overloading.

After a problem has been diagnosed and corrected, it is a good idea to clear the fault history file. This allows the controller to accumulate a new file of faults. By check the new history file at a later date, you can readily determine whether the problem was indeed fixed.

Or checking the problems according the flashing way of the STATUS light on the top of the controller, please refer to the details mentioned our service manual which is available separately.

Trouble-Shooting Guide (For Series System):

Symptoms	Possible Causes
The vehicle cannot be started.	<p>A. The controller has no power;</p> <p>a. There is something wrong with the battery or wire connections.</p> <p>b. the fuse of power connection is burnt;</p> <p>c. the resistance for pre-charging is broken.</p> <p>B. No signal is transmitted to the controller:</p> <p>a. The power key is damaged or its wiring becomes disconnected.</p> <p>b. The accelerator of the pedal is damaged.</p> <p>c. There is something wrong with acceleration pedal</p> <p>d. The polarity diode is broken or has short cut.</p> <p>a. The green wire connecting the acceleration pedal and the controller KSI is disconnected;</p> <p>C. The contacting point of the contactor becomes stick.</p> <p>D. The controller of the motor is damaged.</p>
The vehicle can only move forward and cannot be reversed, or vice versa	<p>a. The switch is damaged.</p> <p>b. The inserts on the commutators become loose.</p> <p>c. The commutators are damaged.</p>
The vehicle can only run at slow speed	<p>a. Insufficient Battery;</p> <p>b. Handbrake is not engaged or brake shoe is not return;</p> <p>c. Accelerator Defect;</p> <p>d. Controller Defect</p>

Trouble Shooting Guide (For SEPEX System)

Please refer to Troubleshooting Chart of Curtis SEPEX controller.

Please contact your local dealer or a qualified electrician to work on the problems related to the motor, controller or electrical system of the vehicle when you are not able to fix them.

Maintenance of Rear Axle:

While using your vehicle, the rear axle should be maintained daily, periodically and randomly.

1. Periodic maintenance means the driver should do some daily maintenance before, in or after driving to prevent anything unexpected happen. The maintenance is focused on clearance and examine as followed:

- 1) Clean the dust and mud on the cover to keep the axle clean
- 2) Make sure all the connection are in good condition, in case there is any damage if any contact sticks or there is any travel in the contact.
- 3) Make sure the gear oil is enough, and add some in time if it is not.

- 4) Check if there is any link in the connection and transmission units or any unusual sound inside the axle;
- 5) Check the brake drum, the exterior temperature and smell, it should be adjusted and repaired in time if there is any problem.
- 6) Check if the breather valve ventilate or not in case the oil linked;
- 7) Check if there is any section in the parking brake cable broken or loosen, replace a new one if there is necessary.

2. Periodic maintenance: The axle should be done first grade maintenance, second grade maintenance and third grade maintenance
 First grade maintenance focuses on lubricate, fixation and gear oil replacement.
 Second grade maintenance focuses on check adjustment and gear oil replacement.
 Third grade maintenance focuses on the whole part cleaning, assembly and gear oil replacement.
 Maintenance in each grand should follow the requirement.

Periodic maintenance following sheet:

Period	Grand
Each Month	Do first grade maintenance as required above
Each 2 months	Do second grade maintenance as required above
Each half year	Do third grade maintenance as required above

7. MAIN TROUBLE AND TROUBLESHOOTING

Symptom(s)	Possible cause(s)	Troubleshooting
The axle housing gear and bearing are damaged untimely and there is too much noise on the final drive	1. The gear oil is insufficient or used improperly	Fill some oil or replace a new one
	2.The bearing is assembled incorrectly	Assembly correctly
	3. Adjust the brake shoe pin shim or the interval.	Adjust or replace
	4.The gear between axle 1 and 2 is not touched tightly	Adjust correctly
	5.The final drive is too noisy: 1)Check if there is any impurity 2.check the if the gear is damaged	Remove the impurity, replace the gear
	6.Axle 1 strikes heavily	Adjust or replace a new one
	7.The rear axle is out of shape (check if it is over loaded)	Replace the rear axle
Lack of breaking force	1. There is interval between the brake shoes and drum.	Adjust the interval
	2. There is oily dirty on the brake shoes or drum.	Remove the impurity
	3.There is air in brake pipe	Dispel the air
	4. The brake pipe leaks.	Repair the leakage or change the brake pipe
	5. The brake shoes are over-rubbed.	Replace a new one
	6. The brake cable is too long or is blocked.	Adjust the brake cable
The brake is difficult to release completely	1.The brake pedal can not bounces back smoothly	Replace a new one
	2.The brake shoe is out of shape	Refit or replace
	3.The is some block on the transmission	Refit or replace
The oil leaks	1.The Oil Seal is damaged	Replace a new one
	2.Too much Oil	Adjust the oil level

Wheel Replacement

WARNING!

Before doing anything to the wheel and tire, please make sure the power key is positioned on OFF position.

Please read the tire manufacturer's instructions and never exceed their recommendation.

Protect face and eyes from escaping air when removing the valve core.

Be sure the mounting/demounting machine is anchored to floor.

Wear safety equipment when mounting/demounting the wheel and tire.

To remove a wheel on the vehicle:

- 1)Blocking the wheel, then loosen the wheel nuts
- 2)Use a jack to lift the vehicle, and then remove the wheel nuts and the wheel.

To install a wheel on the vehicle:

- 1)Use a jack to lift the vehicle, and then put the wheel onto the wheel hub with lug nuts.
- 2)Finger tighten the lug nuts, then tighten lug nuts to 50-85ft.lbs.(70-115Nm) in 20ft.lbs.(30Nm) increments following the 'cross sequence' pattern

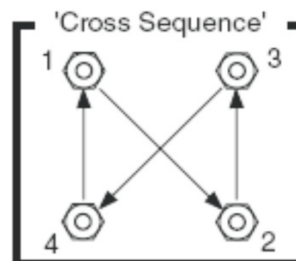

- 3)Remove the jack.

If the tire is flat, remove the wheel and inflate the tire to the maximum recommended pressure for the tire. Immerse the tire in water to locate the leak and mark with chalk. Place tire plug according to the manufacturer's specifications.

Brake Adjustment

WARNING!

If you have any problem with the brakes, please consult with our dealers. Brake failure can result in serious accident or physical danger.

- ① step down the brake pedal with a force of 30kg or so, keeping the vehicle moving not more than 2/3 of its rated range.
- ②The clearance for the brake plate is self-adjusted. Under a force of around 20kgs, the parking brake handle should be fixed in one gear from 5 to 10 ratchets. When this brake handle is released completely, the brake function will stop.
- ③ Inspect and change brake shoe, add lubrication into the brake bearing periodically.

Before you operate the vehicle, please press down on the brake pedal several times to make sure the brakes are functioning properly.

8. LUBRICATION

- ① Use 901 car brake oil DOT3 as brake oil;
- ② Use 1L of 90GL hypoid gear oil for the rear axle;
- ③ Lubrication points (use butter): a. steering gears; b. middle shaft; c. horizontal bars; d. steering ball joints; e. bearings;

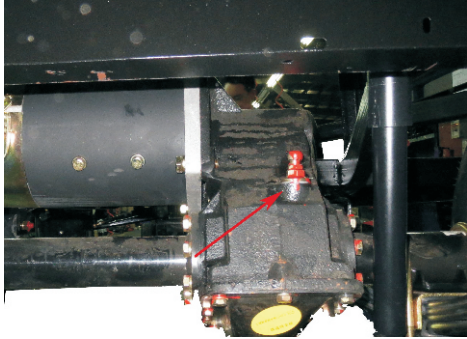

Rear End

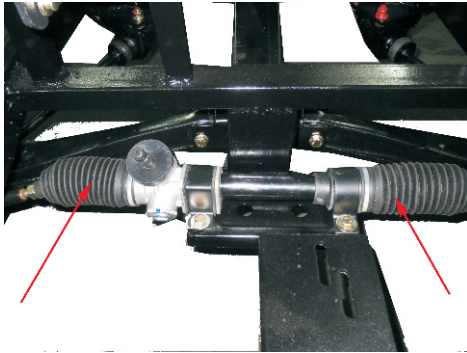

Steering Gear

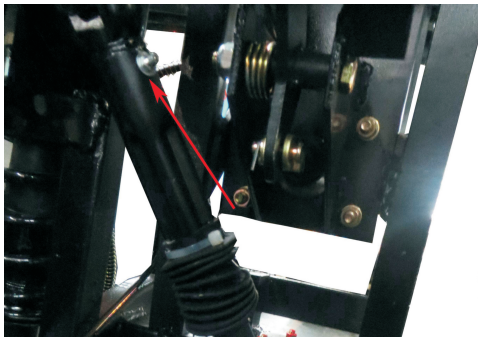

Middle shaft

9. RUNNING-IN OF NEW VEHICLE

In order to guarantee the performance of the vehicle and enhance its reliability and working life, its parts should experience a certain period of running-in before it works under peak load. Each new vehicle is required to give one month of running-in time or 1000kms running-in distance, detail procedure is as per the following.

- i. Before running-in, shall check the capacity of oil, electrolyte and brake oil, if any insufficiency is found, shall fill it accordingly.
- ii. The tire pressure shall comply with the rated pressure marked on the tire.
- iii. Limit the speed of the vehicle to control the current of the vehicle under 40A during driving.
- iv. Often check and tighten regularly the fixing parts of each connecting points

10. PERIODIC MAINTENANCE CHARTS

Regular maintenance is required for the best performance and safe operation of the vehicle.

WARNING!

Make sure to turn off the power key and apply the park brake when you do the maintenance unless otherwise specified. If the owner is not familiar with the maintenance of this vehicle, this work should be done by the dealer from who you get your vehicle: cm³

1D – per day 1W – per week 1M – per month 1Q – per quarter 1Y – per year

Item	Descriptions	1D	1W	1M	1Q	1Y
Battery	1. Check the liquid level. Please add the distilled water if necessary.	Y				
	2. Charge the battery	Y				
	3. Tighten the nut on the battery cable		Y			
	4. Check if the battery is over-discharged (the battery power meter flashing)	Y				
	5. Check the liquid density of the battery, standard density should be $1.277 \pm 0.007 \text{g/cm}^3$ (80o F. or 25°C) when the battery is fully charged.		Y			
	6. Check if the battery is charged fully by 2 ways: a) using the hydrometer; b) checking the battery power meter;	Y				
	7. Clean the surface of battery		Y			
Charger	8. Observe the charging status, check if the charger plug becomes hot.	Y				
	9. Clean the surface of the charger. Do not get any water inside the charger.		Y			
Controller	10. Check if all terminals are tightened properly. Please do this after the power is off.				Y	
	11. Clean the surface of the controller.				Y	
	12. Check if the solenoid is in order, checking its touching point.					Y
Motor	13. Check if any water gets in. Check if it becomes too hot.	Y				
	14. Check if the carbon brush should be replaced.					Y
	15. Check if the accelerator pedal works well and if it can be released freely and automatically.				Y	
Chassis and body	16. Check if the brake drum and the brake shoe should be replaced or not.Y				Y	
	17. Check if the hand brake functions. (Applicable for vehicle with hand brake).Y				Y	
	18. Check if the hose and tube for the brake liquid leaking. (Applicable for vehicle with hydraulic brake)			Y		
	19. Check if the brake liquid inside the brake liquid tank is enough. (Applicable for vehicle with hydraulic brake)			Y		
	20. Check the air pressure inside the tire, check if the tire surface is worn, and check if the nuts are tightened properly		Y			
	21. Check if the shock absorber has any oil leaking, flat or abnormal noise			Y		
	22. Check if there is oil leaking on the gear box and the rear end		Y			
	23. Add the lubricant inside the wheel hub, steering system				Y	
	24. Adjust the toe-in of the front end				Y	
	25. Clean the body and seat				Y	

After above maintenance, drive the vehicle to check if the vehicle works properly.

11. STORAGE

Please follow the steps as below when the vehicle is stored.

1. Check the liquid level inside the battery; recharge it fully before storing the vehicle.

WARNING!

Please charge the battery once a month if your vehicle will be stored more than one month.

2. Turn the power key to OFF, remove the key, and store the key in a safe position.

3. Move the tow switch into TOW position on the controller cover.

4. Check the tire pressure to make sure its pressure is set to recommended pressure.

5. Clean the exterior of the vehicle and apply the rust inhibitor.

6. Cover the vehicle with a breathable cover and store it in a dry, safe and well-ventilated place.

7. If the vehicle is planned to store for a long time, then please check the liquid level inside the battery once a month, recharge the battery

12. WIRING DIAGRAM

1)Wiring diagram for vehicle 48V with Curtis Controller 1204 (FIG. 1)

2)Wiring diagram for vehicle 48V with Curtis Controller 1268 (FIG.2)

3)Wiring diagram for vehicle 48V with Zapi Controller ACE2 (FIG.3)

This manual tries to be as sound and elaborate as possible in literal and figurative description as well as technical description on the basis of existent data. At the same time, our company reserves the right to alter the content of this manual and this manual is subject to change without prior notice; in addition, our company has the final interpretation right of this manual.

All rights reserved.

March.2015

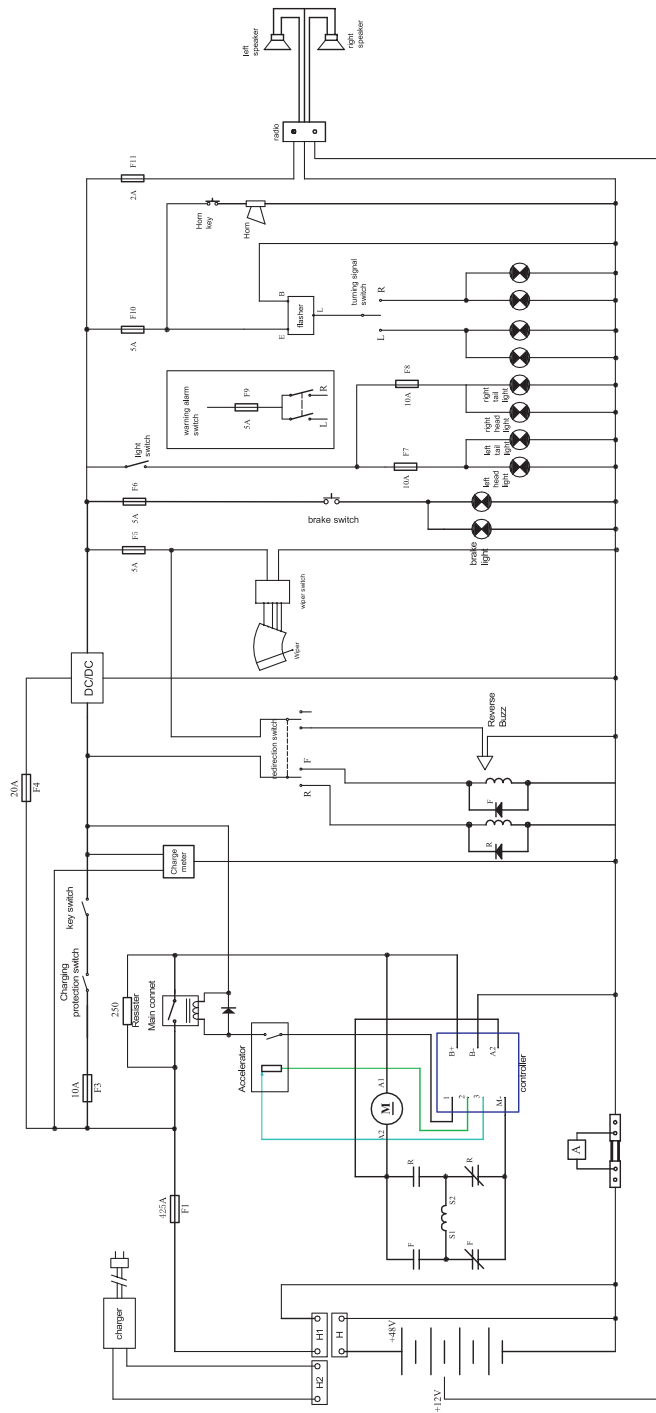

FIG.1

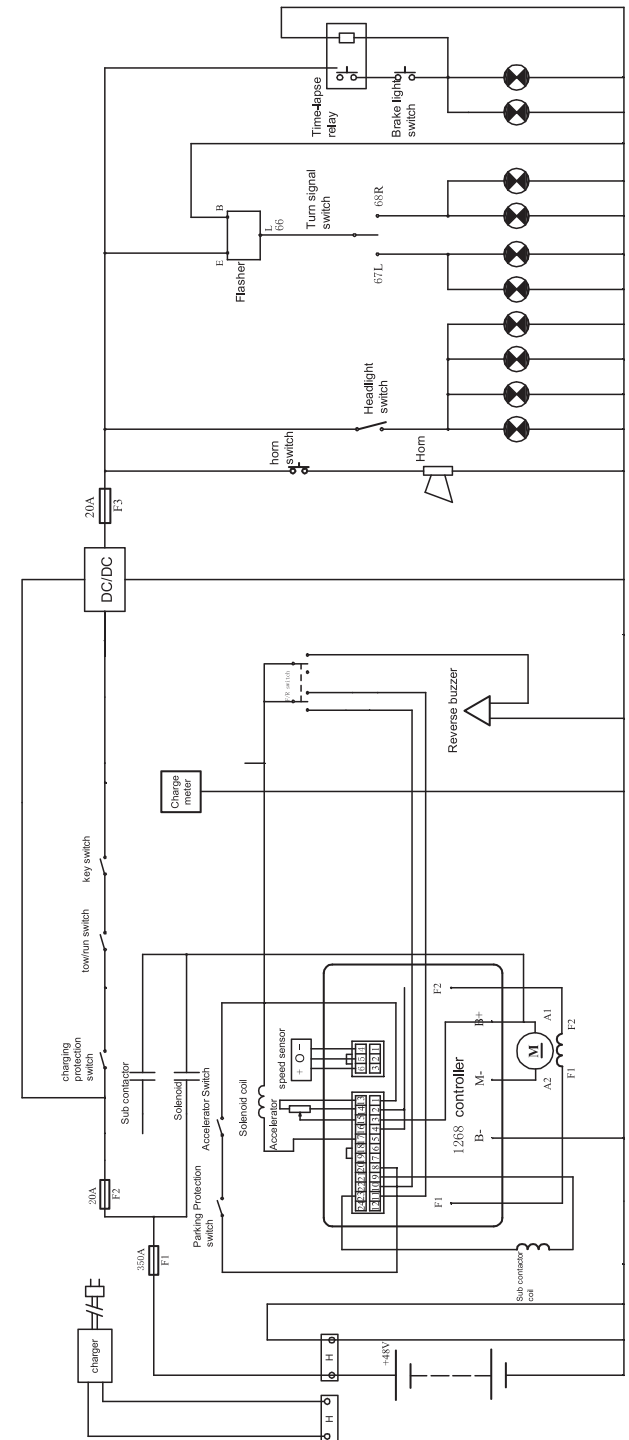

FIG.2

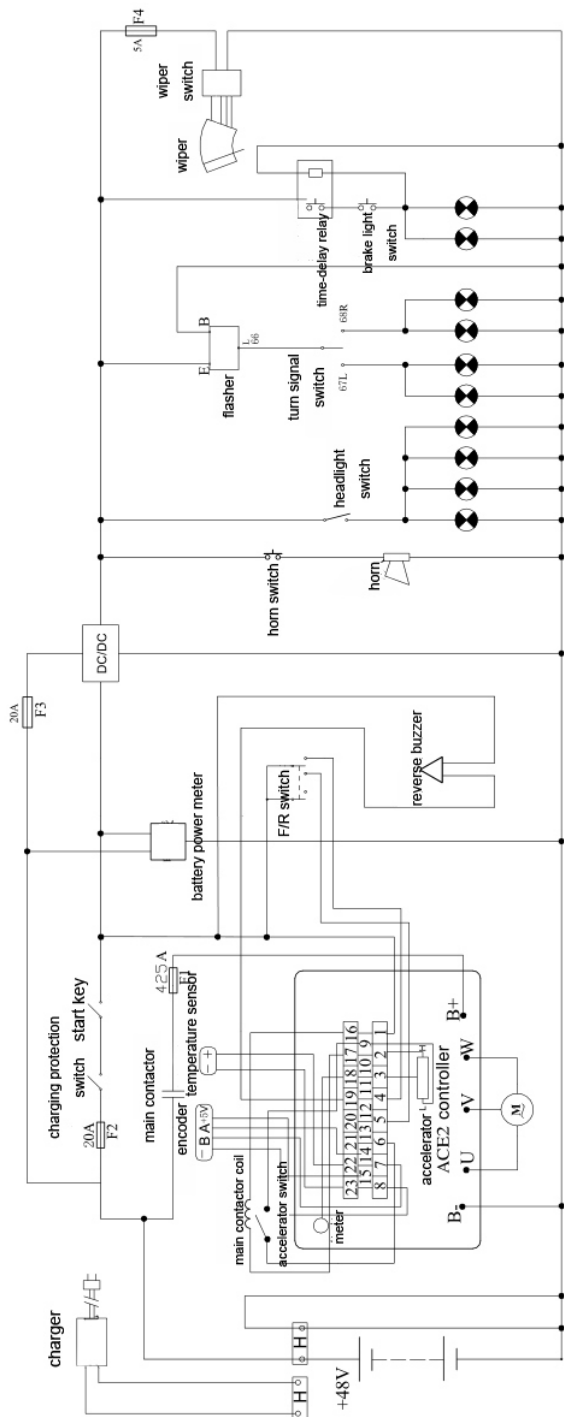

FIG.3